

QUICK START GUIDE  
**ONLINE UPS**  
UPS-OL1500R | UPS-OL2200R | UPS-OL3000R

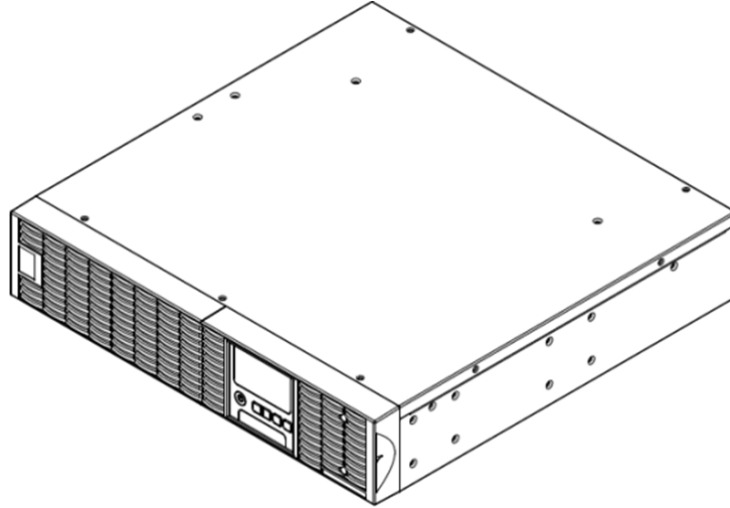

## THANK YOU

Thank you for purchasing an online UPS product. Please read these instructions thoroughly before installing this product.

## PRODUCT FEATURES

- Provides double-conversion (zero transfer time) online backup protection.
- Expansion battery packs for provisioning additional runtime needs.
- Real time reporting and notifications of battery life and when replacement is required.
- Removable LCD display and power switch for remote convenience.
- Access the following link to download the latest version of the Power Manager software and the Online UPS User Manual:

[www.middleatlantic.com/downloads](http://www.middleatlantic.com/downloads)



**Middle Atlantic Products**

May, 2016 I-00791 Rev C

# UNPACKING

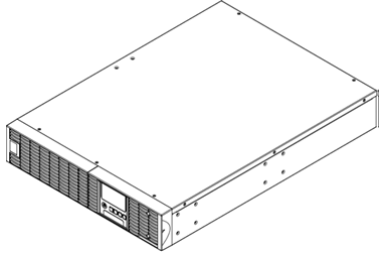
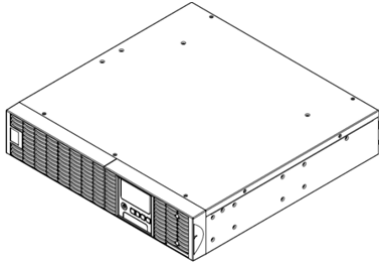

1.5KVA or 2.2K/3KVA UPS



Quick Start Guide

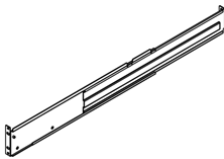

Rackmount Left Rail

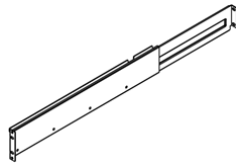

Rackmount Right Rail

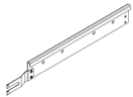

Left Hanging Bracket

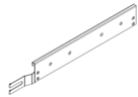

Right Hanging Bracket

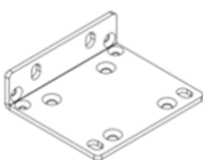

Rackmount Ears (Stand) (2)

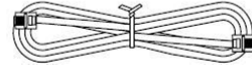
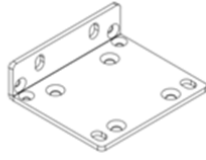

Phone line



USB communication cable



Serial Interface Cable (RS-232)



Flat Head Screws: M5x7L (8)



Pan head screws: M5x12L (4)



Pan Head Screws: M5x6L (6)



Pan Head Screws: 10-32x1/2L (12)



Screw Hole Dust Covers (12)



Rubber Feet (12)

# HARDWARE INSTALLATION

## Rackmount Installation

**WARNING:** Unplug and allow the unit to fully discharge before performing installation steps.

**AVERTISSEMENT:** Débranchez et laissez l'appareil se décharger complètement avant peforming étapes d'installation.

**WARNING:** For safety instructions, refer to the "Online UPS User Manual" via the link provided on the first page of this guide.

**AVERTISSEMENT:** Pour obtenir des instructions de sécurité, se reporter à la "Online UPS User Manual" via le lien ou le code de QR fourni sur la première page de ce guide.

**NOTE:** Some rackmount steps are pictured with the Online Expansion Battery. The rackmount mounting procedure is the same for both products.

1. Turn off and unplug the unit.
2. Remove the (7) dust covers by prying them from the screw holes.

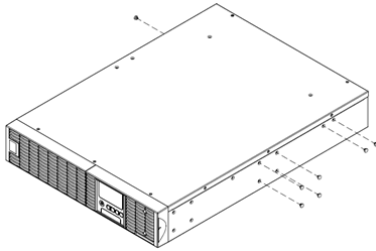

3. Install (2) rackmount ears using (8) M5x7L flat head screws. Also, install (2) hanging brackets using (6) M5x6L pan head screws.

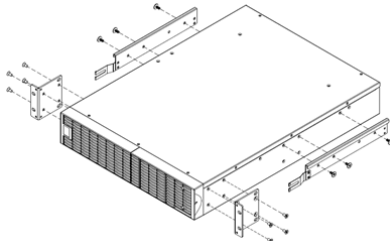

4. Install your rackmount rails. The rails adjust to mount in 48cm (19") panel racks from 52 to 91.5cm (20.5 to 36") deep. Select the proper holes in the rack for positioning the UPS in the rack. The UPS takes up positions 1 through 6.

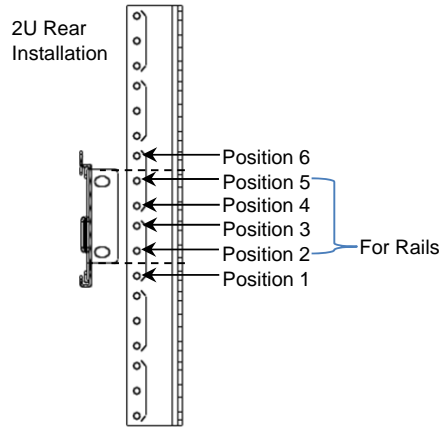
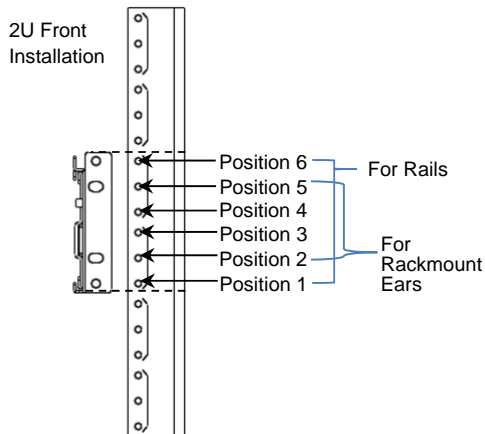

5. Adjust the rackrail depth within specified mounting ranges from step 4. Attach the rackmount rail to your rack with (8) 10-32x1/2L screws and (2 screws for both front and back and for each rail). Tighten all screws.

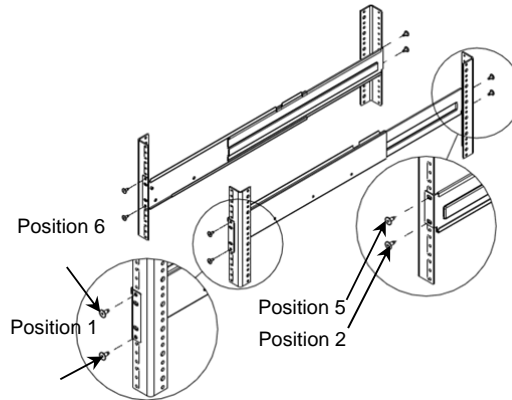

6. Slide hanging brackets on the UPS into the rails mounted in the rack with the front of the unit facing you. Secure the UPS to your rack with (4) 10-32x1/2L screws on the front of the rack (located in positions 2 and 5).

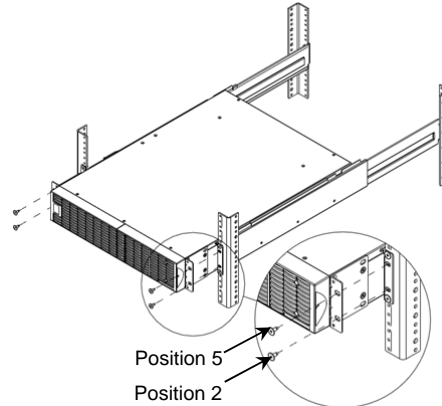

**Sliding Out the UPS From the Rackrail**

1. Turn off and unplug the unit.
2. The UPS is secured from being pulled out of the rack any further than its mid-length by a safety lock mechanism. Use both hands to hold the UPS and press the safety locking tabs to pull the UPS out of the rack.

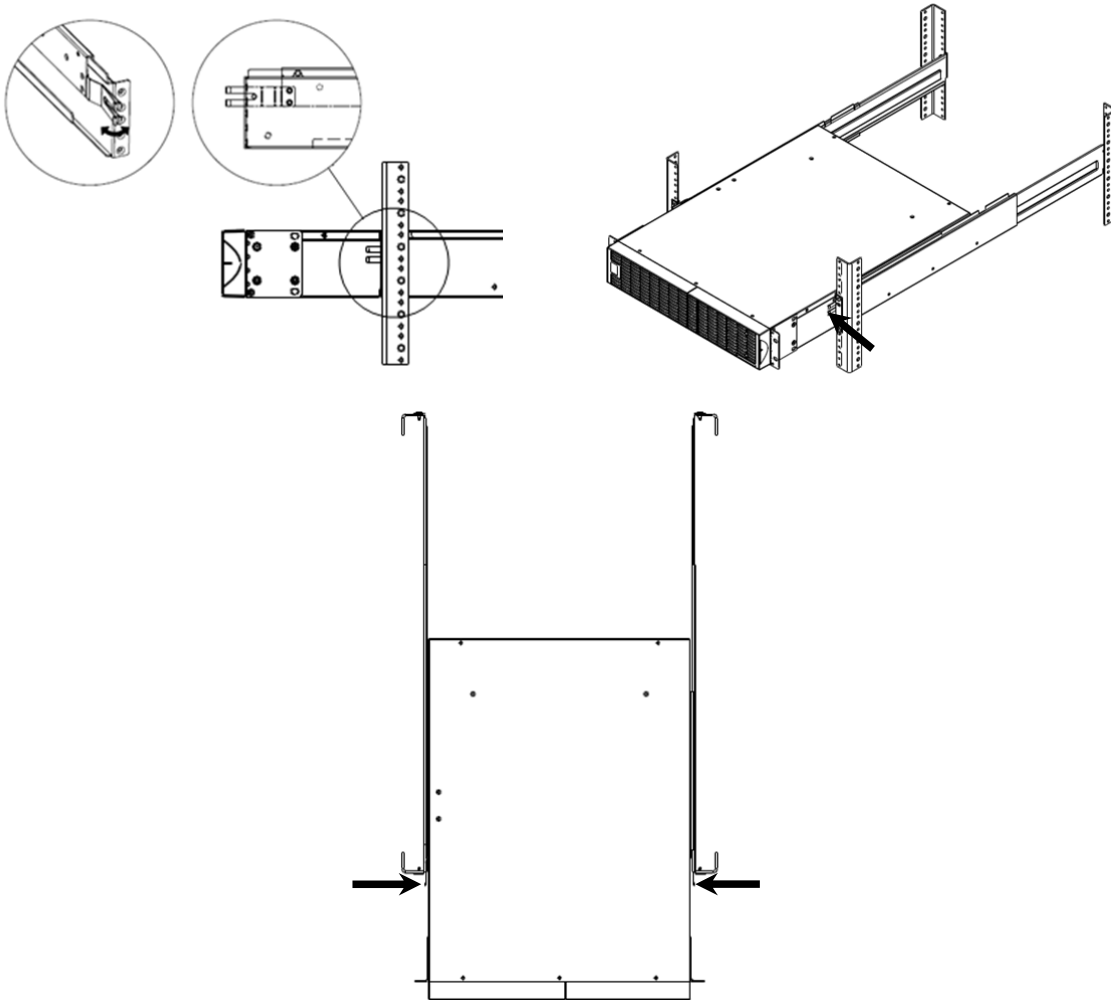

## INSTALLING YOUR UPS SYSTEM

**NOTE:** The steps in this section should only be performed after completing the hardware installation procedures. For more information, see "Hardware Installation" on page 3.

### System Block Diagram

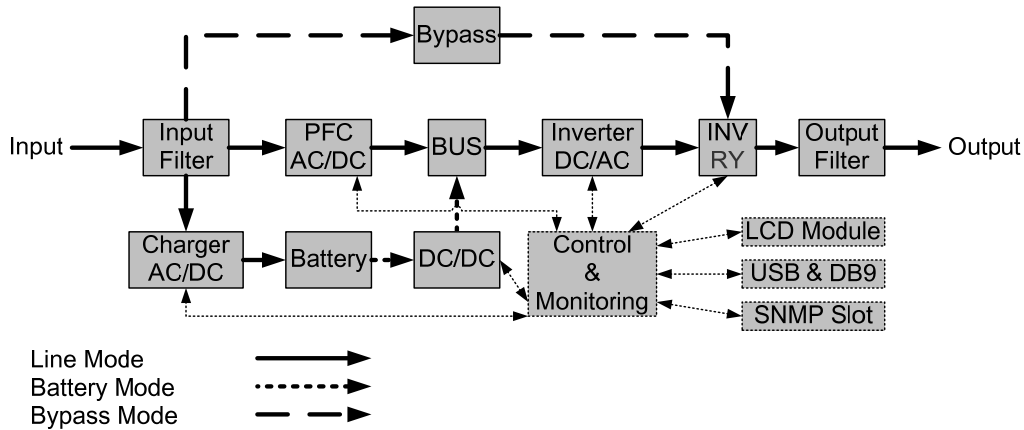

### Hardware Installation Details

1. Battery charge loss may occur during shipping and storage. Before using the UPS, it's strongly recommended to charge the batteries for four hours to ensure their maximum charge capacity. To recharge the batteries, plug the UPS into an AC outlet.
2. When using the included software, connect either the serial or the USB cable between the computer and the corresponding port on the UPS.  
**NOTE:** If the USB port is used, the serial port will be disabled. They cannot be used simultaneously.  
After connecting to either the USB port or the Serial port on the UPS, a computer with the Middle Atlantic Power Manager Software installed can control the operating schedule, battery test, outlets, as well as obtain UPS status information. However, other computers with Middle Atlantic Power Manager Software can only obtain UPS status information via LAN connection.
3. Connect your computer, monitor, and any externally powered data storage device (hard drive, tape drive, etc.) into the outlets only when the UPS is off and unplugged. DO NOT plug a laser printer, copier, space heater, vacuum, paper shredder or other large electrical device into the UPS. The power demands of these devices will overload and possibly damage the unit.
4. To protect a fax machine, telephone, modem line or network cable, connect the telephone or network cable from the wall jack outlet to the jack marked "IN" on the UPS and connect a telephone cable or network cable from the jack marked "OUT" on the UPS to the modem, computer, telephone, fax machine, or network device.
5. Press the ON/OFF switch to power on the UPS. The Power-On indicator light will display when activated. If an overload is detected, an audible alarm will sound and the UPS will continuously emit two beeps per second. Before resetting the unit, unplug some equipment from the outlets first. Make sure your equipment carries a load current within the unit's safe range. Refer to "Technical Specifications" in the User Manual for more information.

6. This UPS is equipped with an auto-charge feature. When the UPS is plugged into an AC outlet, the battery will automatically charge, even when the unit is switched off.
7. To maintain an optimal battery charge, leave the UPS plugged into an AC outlet at all times.
8. Before storing the UPS for an extended period of time, turn the unit OFF. Then cover it and store it with the batteries fully charged. Recharge the batteries every three months to ensure their full capacity and maintain the longest possible battery life. Maintaining a good battery charge will help prevent possible damage to the unit from battery leakage.
9. The UPS has one USB port (default) and one Serial port that allow connection and communication between the UPS and any attached computer running the Middle Atlantic Power Manager Software. The UPS can control the computer's shutdown during a power outage through the connection while the computer can monitor the UPS and alter various programmable parameters.  
**NOTE:** Only one communication port can be used at a time. The port not in use will automatically become disabled or the serial port will be disabled if both ports are attached.
10. EPO (Emergency Power Off) Port: EPO ports allow administrators the capability to connect the UPS unit to customer-supplied EPO switches. These installations give operators a single access point to immediately power-off all equipment connected to the UPS during an emergency.
11. To avoid electric shock, turn the unit OFF and disconnect the unit from utility power before plugging in the power cord. The power cord must be connected to a properly wired and grounded outlet.
12. The internal UPS temperature increases when fans are not in operation or ventilation is obstructed. When the high temperature sensor activates protection, the UPS generates an alarm and shuts down to avoid unexpected equipment damage. If overtemperature occurs contact Middle Atlantic Product's technical support at 1-800-266-7225.

# BASIC OPERATION

## Power Module Front/Rear Panel Descriptions

**1. Power Button / Power on Indicator:**  
Master ON/OFF for the UPS. Indicates that the UPS is on and supplying power.

**2. UPS Status / Fault / Replace Battery LED Indicator:**  
Indicates the status of the UPS, displaying whether it is operating in Line, Battery or Bypass Mode, if it has an internal fault or if the battery needs to be replaced.

**3. Multifunction LCD Readout:**  
Shows UPS status, information, settings and events.

**4. Function Buttons:**  
Scroll up, scroll down, select and cancel LCD menu.

**5. Input Circuit Breaker:**  
Provides input overload and fault protection.

**6. Battery Backup and Surge Protected Outlets:**  
Provides battery backup and surge protection. They ensure power is provided to connected equipment over a period of time during a power failure.

**Critical / Noncritical Load:**  
Allows the creation of load priorities to ensure that battery power reserves are transferred to specified outlets during a power outage. The unit can be programmed to provide additional runtime for equipment connected to the "CRITICAL" outlets, while stopping the power supply to equipment connected to "NONCRITICAL" outlets after a designated period of time.

**7. Serial Port:**  
The serial port provides communication between the UPS and the computer. The UPS can control the computer's shutdown during a power outage through this connection while the computer can monitor the UPS and alter its various programmable parameters.

**8. USB Port:**  
This is a connectivity port which allows communication and control between the UPS and the connected computer. It is recommended to install the Middle Atlantic Power Manager Software on the PC or Server connected using the USB cord provided.

**9. Surge Protected Communication Ports RJ-45:**  
These ports are used to protect standard RJ-45-based products (LAN lines) and cabling systems from surges.

**10. Relay Output Connector:**  
Converts UPS signals into a single dry-contact output for industrial control.

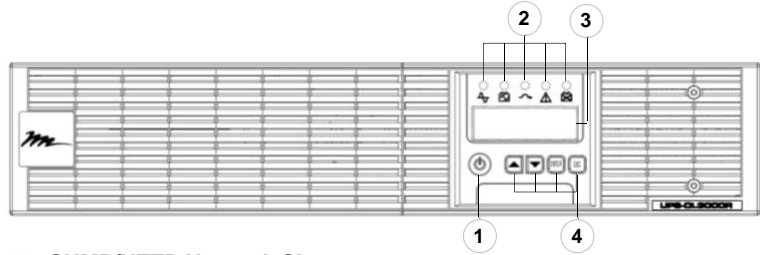

**11. SNMP/HTTP Network Slot:**  
Slot to install the optional UPS-OLIPCARD for remote network control and monitoring.

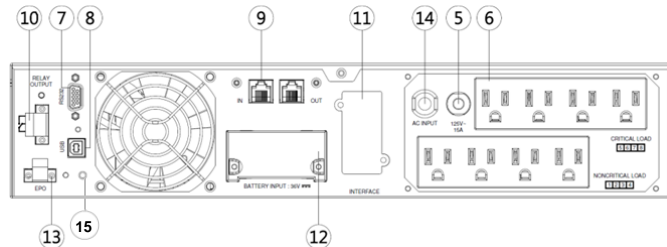

**UPS-OL1500R**

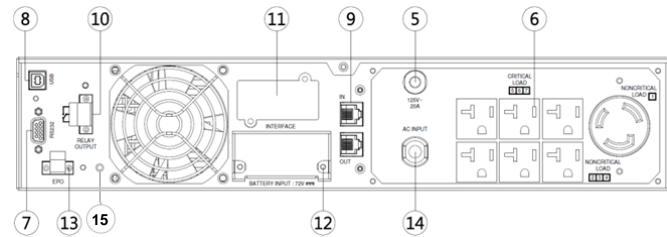

**UPS-OL2200R**

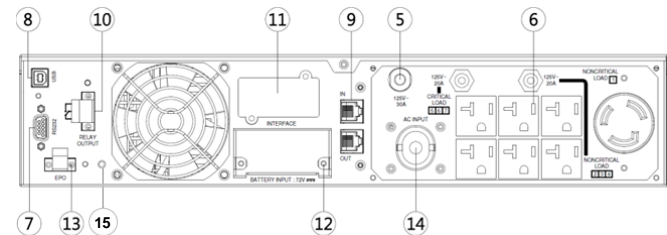

**UPS-OL3000R**

**12. Extended Runtime Battery Module Connector:**  
Connection for additional Middle Atlantic External Battery modules.

**13. EPO (Emergency Power Off) Connector:**  
Enables an emergency UPS Power Off from a remote location.

**14. AC Input Inlet:**  
Connect the AC Power cord to a properly wired and grounded outlet.

**15. Output Shutoff Switch:**  
Pressing this button causes the UPS output to turn off. To re-activate the outputs, press and hold the power button for a few seconds until the front panel display reads READY ON.

## WARRANTY

Middle Atlantic Products, Inc. (the "Company") warrants the product to be free from defects in material or workmanship under normal use and conditions for a period of (3) three years from date of shipment by the Company.

The Company's entire liability to the purchaser, and the purchaser's (or any other party's) sole and exclusive remedy, under this warranty shall be limited, at the Company's option, to either (a) return of and refund of the price paid for, or (b) repair or replacement at the Company's factory of the products purchased, or any part or parts thereof, which the Company has determined to be defective after inspection thereof at the Company's factory. This warranty does not cover damage due to acts of God, accident, misuse, abuse or negligence by parties other than the Company, or any modification or alteration of the products. In addition, this warranty does not cover damage due to improper handling, assembly, installation or maintenance.

THIS WARRANTY IS IN LIEU OF ALL OTHER WARRANTIES OF ANY KIND, EITHER EXPRESSED OR IMPLIED, INCLUDING, BUT NOT LIMITED TO, IMPLIED WARRANTIES OF MERCHANTABILITY AND FITNESS FOR A PARTICULAR PURPOSE. TO THE MAXIMUM EXTENT PERMITTED BY APPLICABLE LAW, IN NO EVENT SHALL THE COMPANY BE LIABLE FOR ANY SPECIAL, INCIDENTAL, INDIRECT, OR CONSEQUENTIAL DAMAGES WHATSOEVER (INCLUDING, WITHOUT LIMITATION, DAMAGES FOR LOSS OF BUSINESS PROFITS, BUSINESS INTERRUPTION OR ANY OTHER PECUNIARY LOSS) ARISING OUT OF THE USE OF THE PRODUCTS PURCHASED, EVEN IF THE COMPANY HAS BEEN ADVISED OF THE POSSIBILITY OF SUCH DAMAGES. THE COMPANY'S LIABILITY TO THE PURCHASER (OR ANY OTHER PARTY) HEREUNDER, IF ANY, SHALL IN NO EVENT EXCEED THE PURCHASE PRICE OF THE PRODUCTS PAID TO THE COMPANY.

### **Corporate Headquarters**

Corporate Voice 973-839-1011 - Fax 973-839-1976 / International Voice +1 973-839-8821 - Fax +1 973-839-4982  
middleatlantic.com - [info@middleatlantic.com](mailto:info@middleatlantic.com)

### **Middle Atlantic Canada**

Voice 613-836-2501 - Fax 613-836-2690 / middleatlantic.ca - [customerservicecanada@middleatlantic.ca](mailto:customerservicecanada@middleatlantic.ca)

### **Factory Distribution**

USA: NJ – CA – IL Canada: ON - BC

**At Middle Atlantic Products we are always listening. Your comments are welcome.**

**Middle Atlantic Products is an ISO 9001 and ISO 14001 Registered Company.**



---

---

**Middle Atlantic Products**

what great systems are built on™

[middleatlantic.com](http://middleatlantic.com) ■ 800.266.7225